

MAXI-STAND

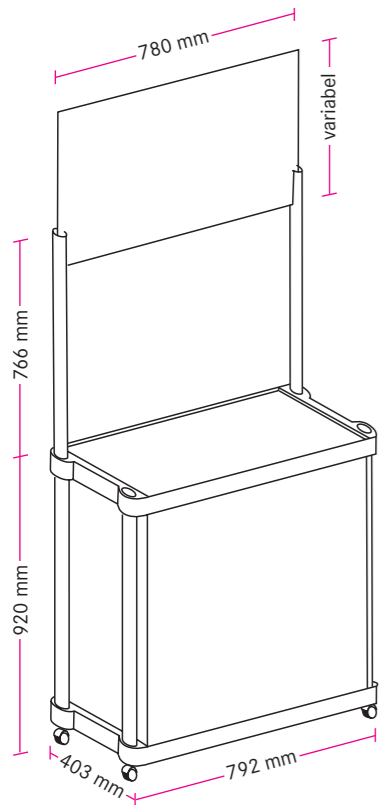

MAXI-STAND

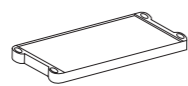
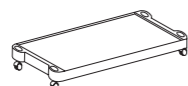
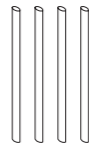
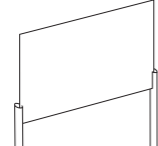
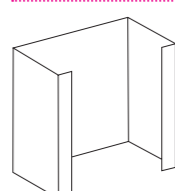
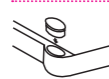
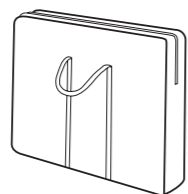

	Oberer Boden	B 404 mm / L 794 mm <i>Nutzbare Stellfläche B 400 mm / L 704 mm.</i>
	Unterer Boden	B 404 mm / L 794 mm <i>Mit feststellbaren Lenkrollen, ø 50 mm.</i>
	Stützrohre	L 795 mm
	Rohr mit Schlitz für Plakat	L 795 mm
	Sockelverkleidung, dreiteilig, Polystyrol	<i>Außenflächen können im Siebdruckverfahren bedruckt werden.</i>
	Abdeckkappe	<i>Zum Verschließen der vorderen Rohraufnahmen im oberen Boden.</i>
	Tragetasche	

ø Durchmesser
B Breite
L Länge
H Höhe
T Tiefe
C Maximale Belastung

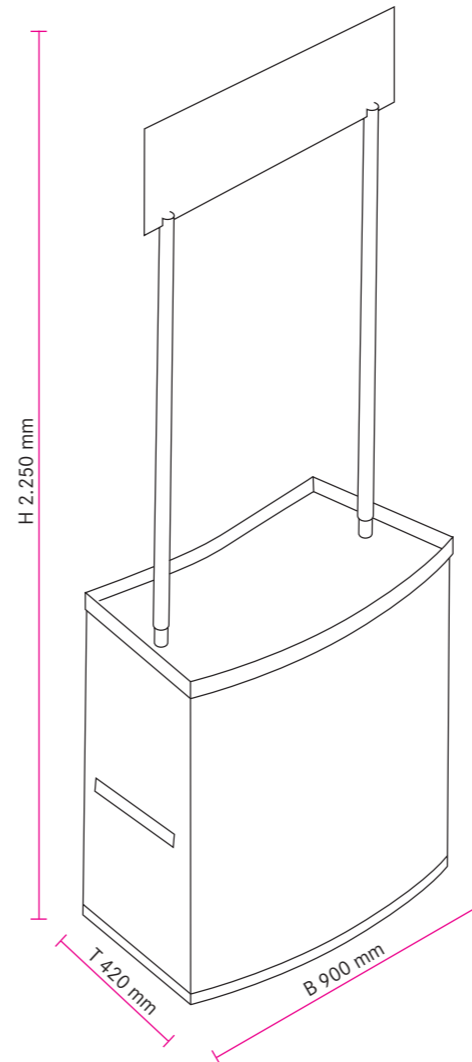
DEMO-STAND

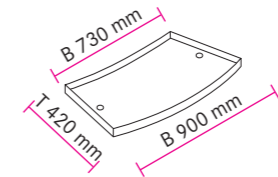
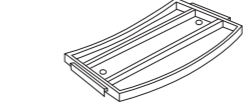
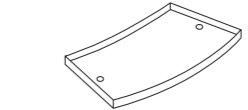

DEMO-STAND

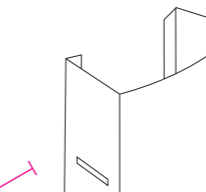
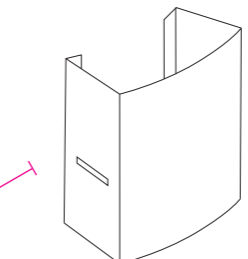
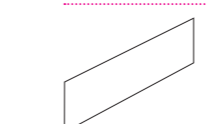
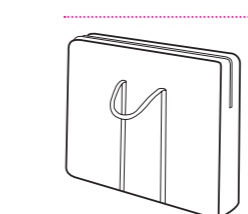
	Oberer Boden	B 420 mm / L 900 mm C 30 kg
	Mittlerer Boden	
	Unterer Boden	
	Rohre ohne Schlitz	
	Rohre mit Schlitz für Plakate	
	Sockelverkleidung, dreiteilig	<i>Außenflächen können im Siebdruckverfahren bedruckt werden.</i>
	Plakat	
	Tragetasche	

ø Durchmesser
B Breite
L Länge
H Höhe
T Tiefe
C Maximale Belastung